



Surgical Company



NEUROSURGERY

Laminectomy Rongeur

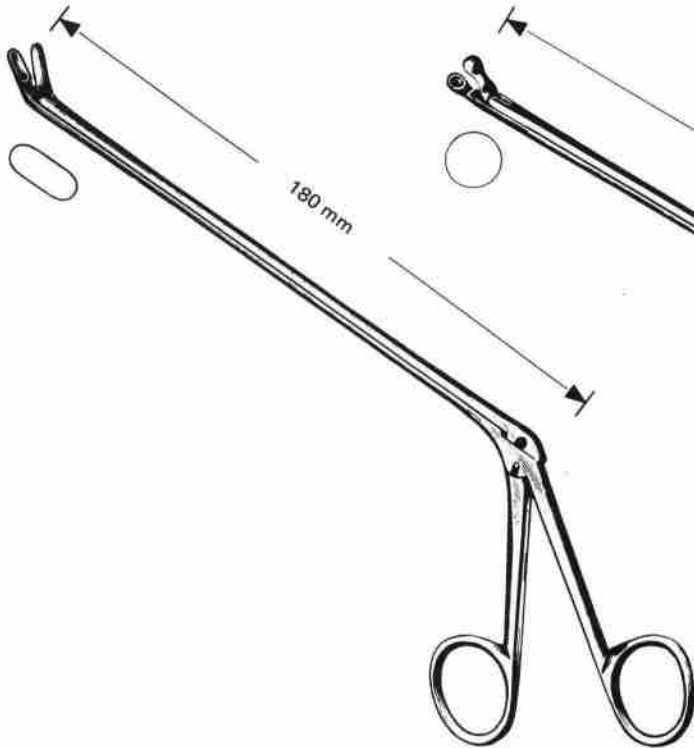

GRUENWALD
SOS 08-001
25cm/10"

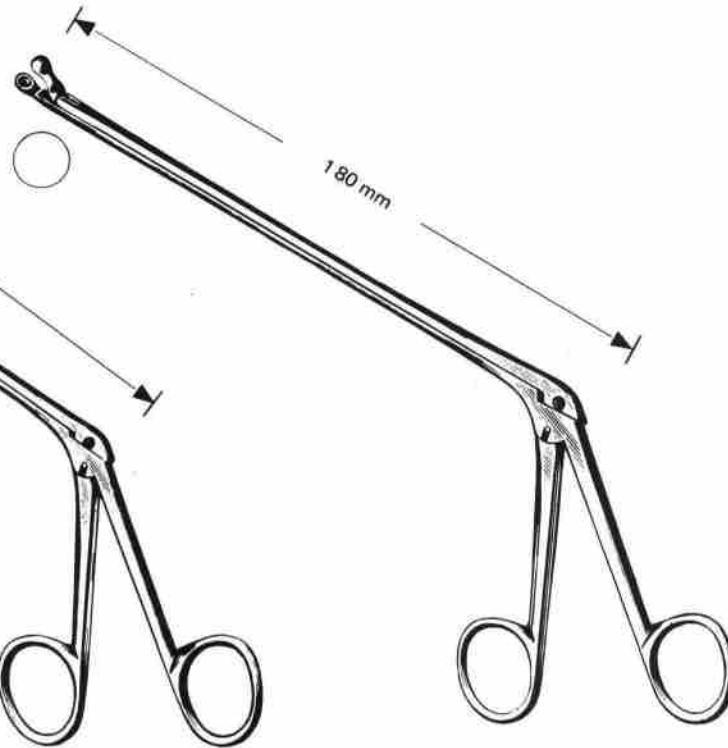

OLDBERG
SOS 08-002
25cm/10"

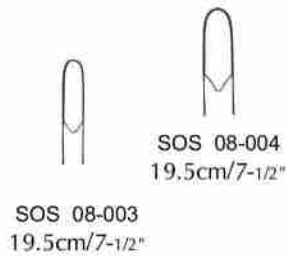

SOS 08-003
19.5cm/7-1/2"

SOS 08-004
19.5cm/7-1/2"

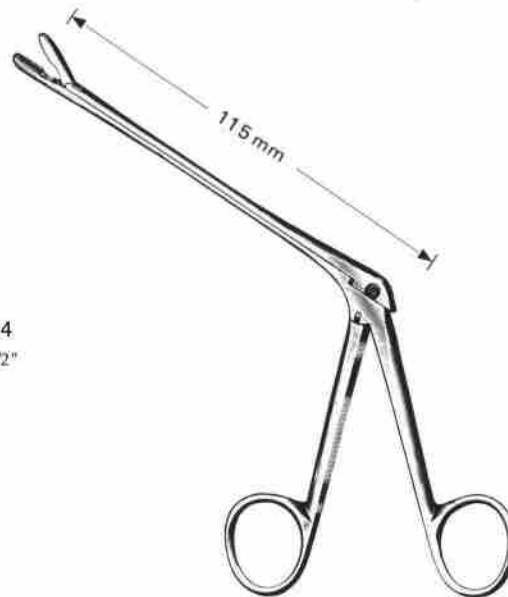

SPURLING LOVE



Surgical Company



NEUROSURGERY

Intervertebral Disc Rongeurs

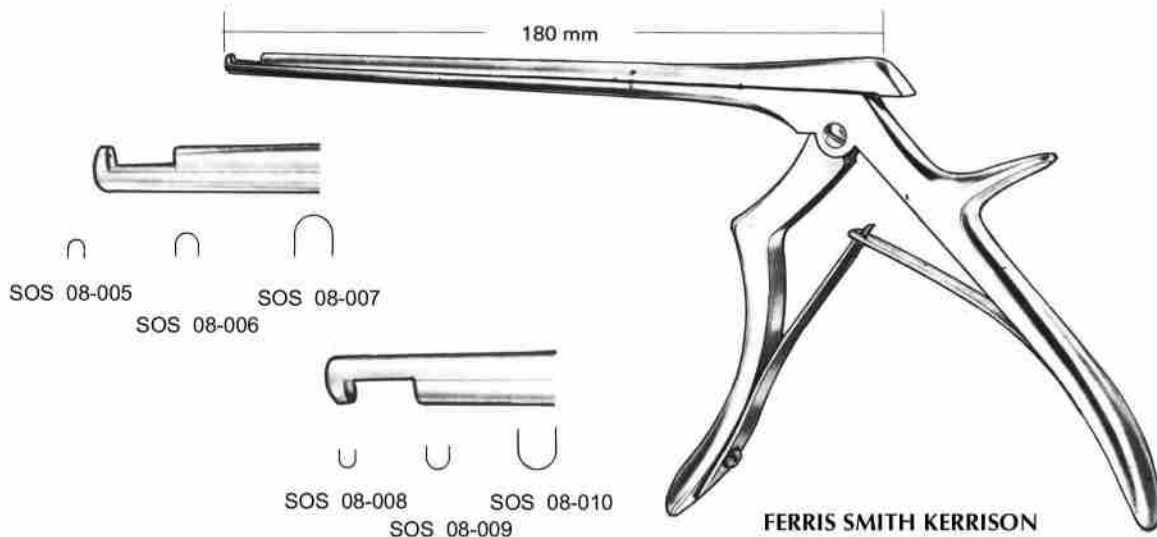

Length of Shaft	Width of Bite	SOS 08-005	SOS 05-006	SOS 05-007
180mm/7"	2mm	SOS 08-005	SOS 05-006	SOS 05-007
180mm/7"	3mm	SOS 08-008	SOS 05-009	SOS 05-010
180mm/7"	5mm	SOS 08-011	SOS 05-012	SOS 05-013

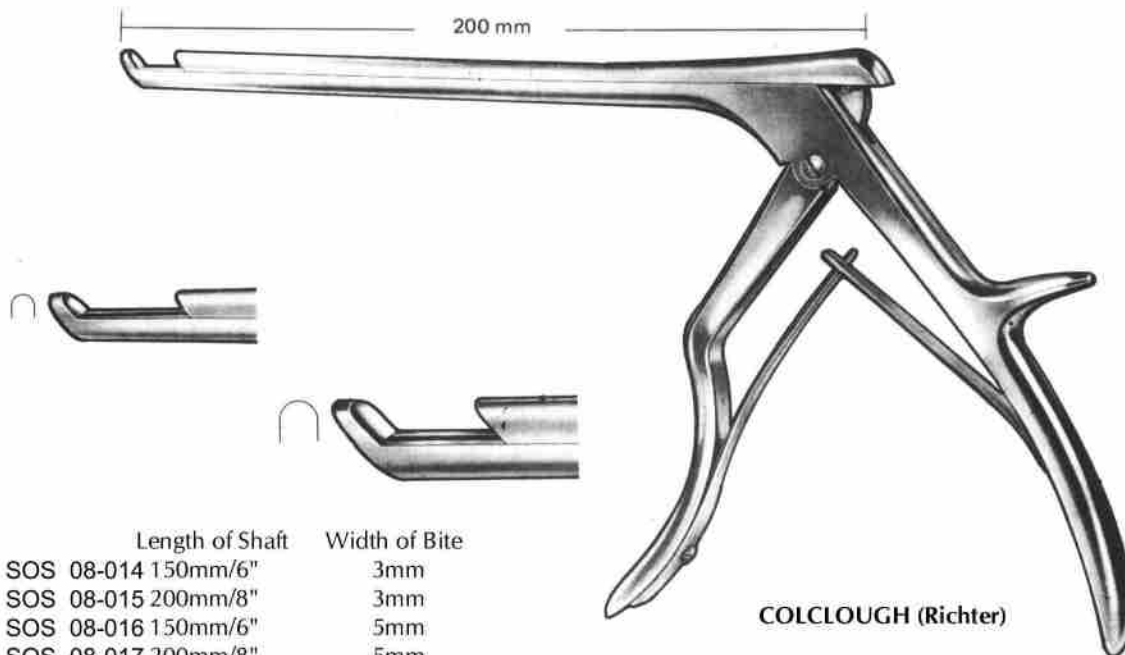

Length of Shaft	Width of Bite
SOS 08-014 150mm/6"	3mm
SOS 08-015 200mm/8"	3mm
SOS 08-016 150mm/6"	5mm
SOS 08-017 200mm/8"	5mm

177



Surgical Company



NEUROSURGERY

Intervertebral Disc Rongeurs

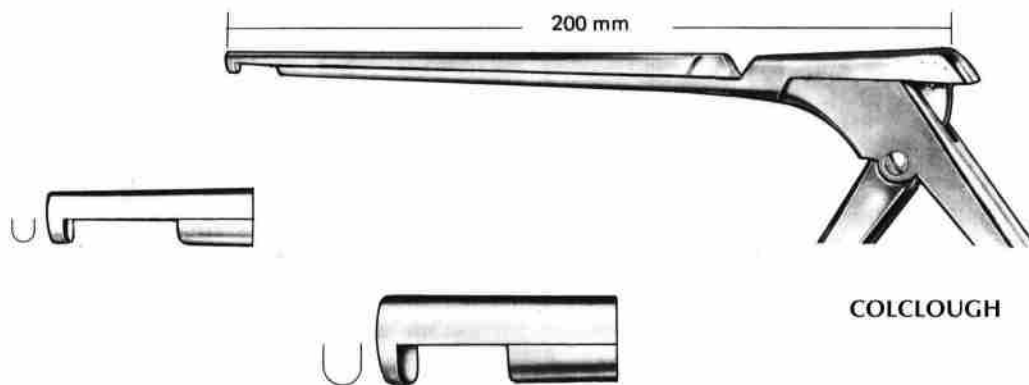

	Length of Shaft	Width of Bite
SOS 08-018	150mm/6"	3mm
SOS 08-019	200mm/8"	3mm
SOS 08-020	150mm/6"	5mm
SOS 08-021	200mm/8"	5mm

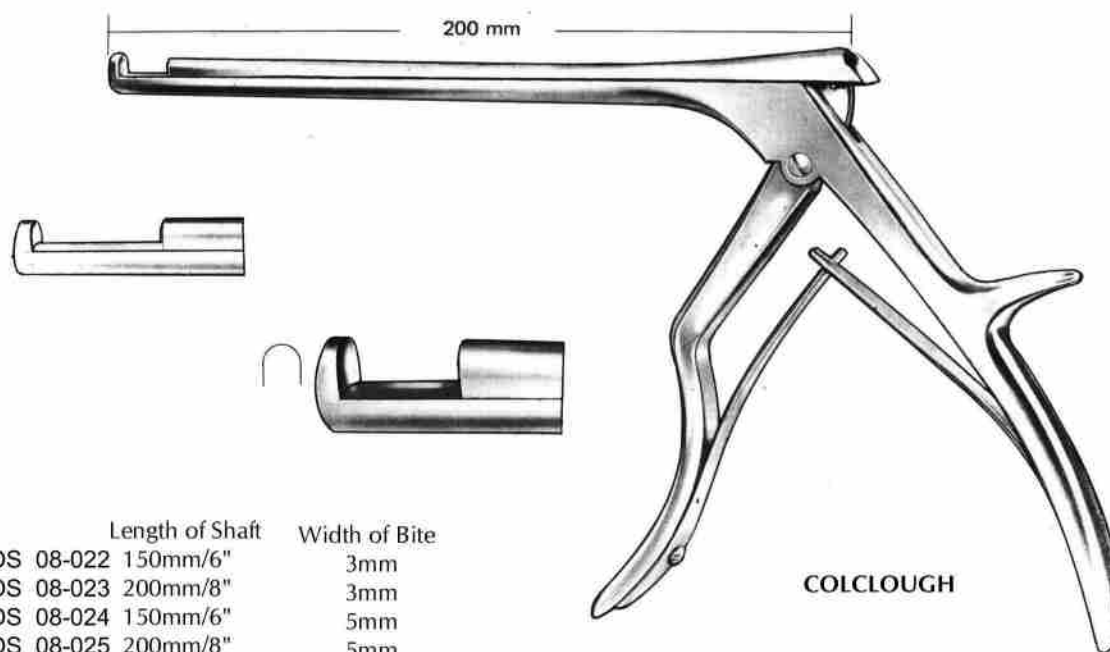

	Length of Shaft	Width of Bite
SOS 08-022	150mm/6"	3mm
SOS 08-023	200mm/8"	3mm
SOS 08-024	150mm/6"	5mm
SOS 08-025	200mm/8"	5mm



Surgical Company



NEUROSURGERY

Exporing Cannula, Section Tube and Tampons Cannula



SEIFFERT
SOS 08-026
12.5cm/5"

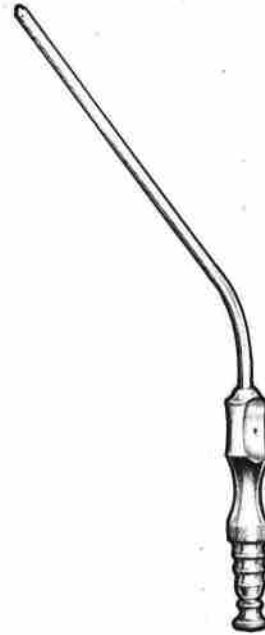

FRAZIER
17cm/6-3/4"
SOS 08-027 6 FG
SOS 08-028 8 FG
SOS 08-029 10FG
SOS 08-030 12FG



ADSON
SOS 08-031
21cm/8-1/4" - (4mm)



FRAZIER
SOS 08-032
12cm/4-3/4" - (3mm)



Surgical Company

NEUROSURGERY

Nerve Hooks



CUSHING
19cm/7-3/4"



SOS 08-033



SOS 08-034



DANDY
SOS 08-035
20cm/8"



DANDY
SOS 08-036
20cm/8"



DANDY
SOS 08-037
20cm/8"



Surgical Company



NEUROSURGERY

Nerve Root Retractor and Brain Spatula



7 x 9 mm SOS 08-038
 11 x 13mm SOS 08-039
 15 x 18mm SOS 08-040
 18 x 22mm SOS 08-041

OLIVECRONA
18cm/7"

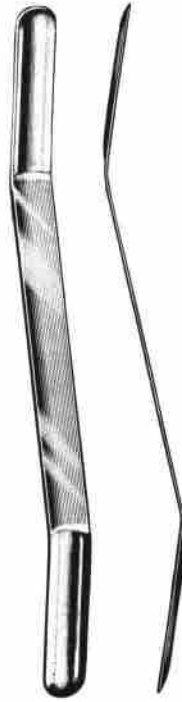

SOS 08-042
 SOS 08-043
 SOS 08-044
 SOS 08-045

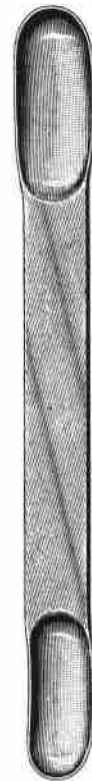

CUSHING
 SOS 08-046 17cm/6-3/4"
 SOS 08-047 20cm/8"
 SOS 08-048 28cm/11"



LOVE
 19cm/7-3/4"
 SOS 08-049 Fig:1

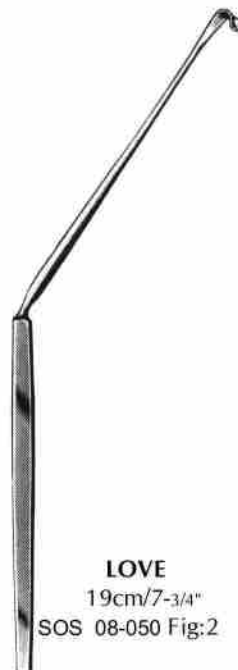

LOVE
 19cm/7-3/4"
 SOS 08-050 Fig:2

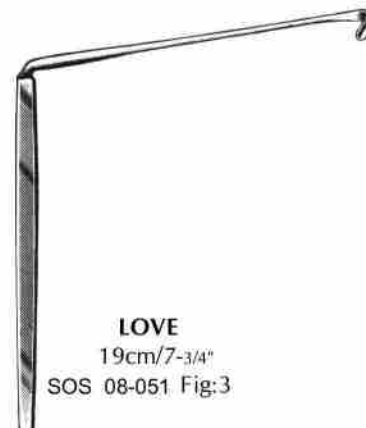

LOVE
 19cm/7-3/4"
 SOS 08-051 Fig:3

NEUROSURGERY

Clip Applying Forceps

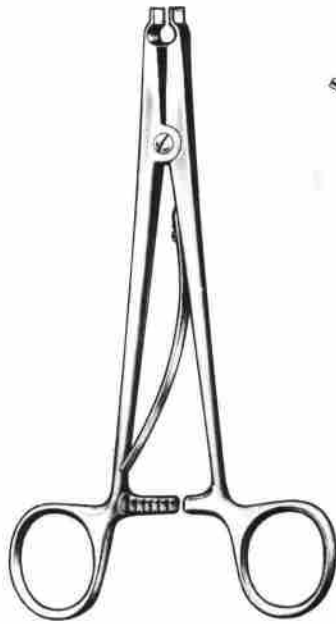

RANEY
SOS 08-052
16.5cm/6-1/2"

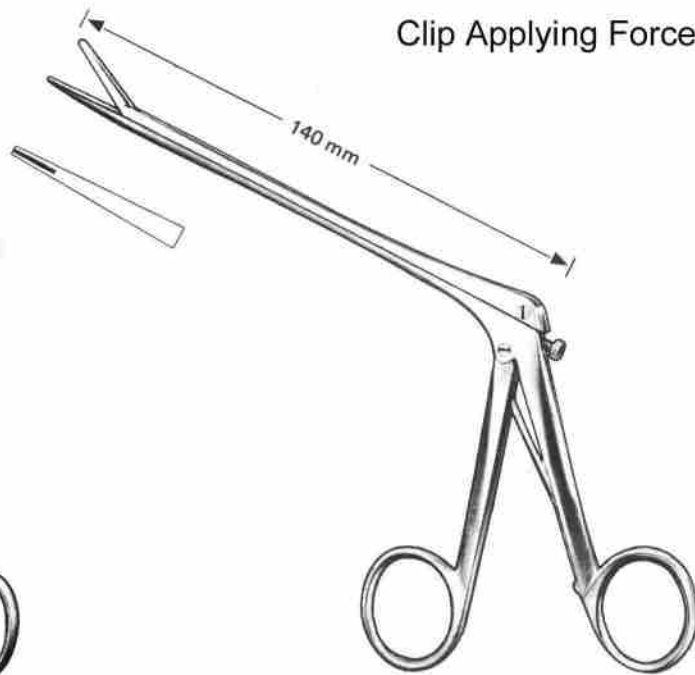

OLIVECRONA TOENNIS
SOS 08-053
14cm/5-1/2"

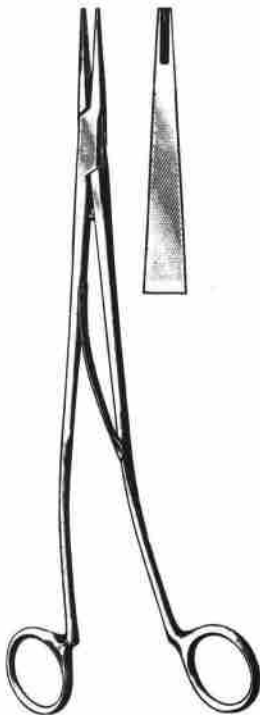

SWEET
SOS 08-054 23cm/9"
SOS 08-055 25cm/10"



SMITHWICK
SOS 08-056 23cm/9"
SOS 08-057 26cm/10-1/4"

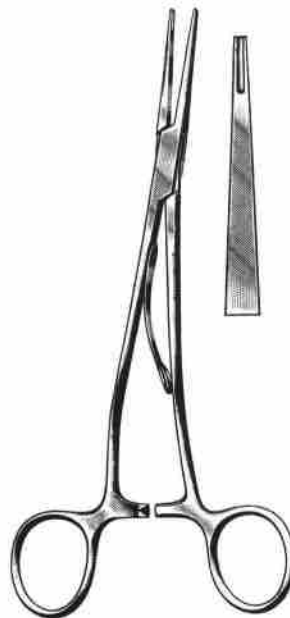

McKENZIE
SOS 08-058 15cm/6"
SOS 08-059 19cm/7-1/2"

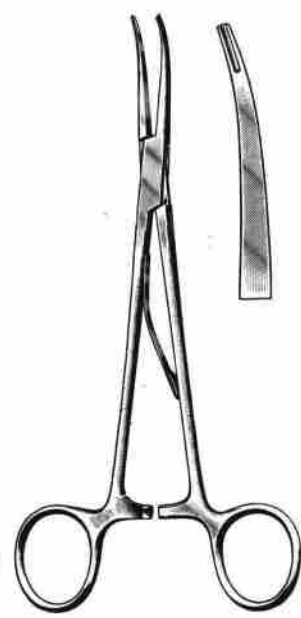

McKENZIE
SOS 08-060 15cm/6"
SOS 08-061 19cm/7-1/2"



Surgical Company

NEUROSURGERY

Drill Points



SOS 08-062
3.5mm (Dia)



SOS 08-063
5mm (Dia)

Cervical Traction Tongs

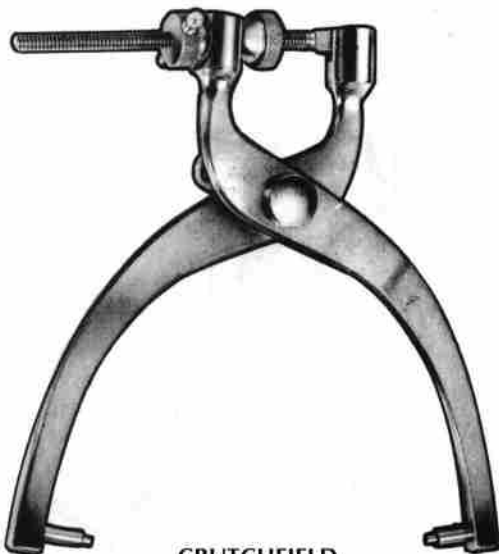

CRUTCHFIELD
SOS 08-064

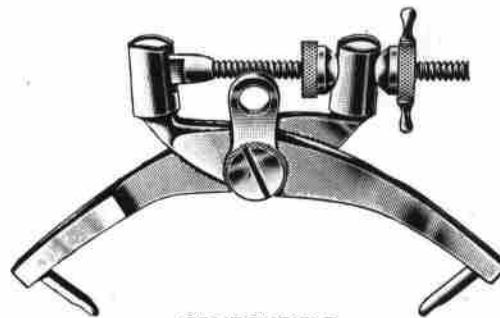

CRUTCHFIELD
SOS 08-065



Surgical Company

NEUROSURGERY

Handle for Wire Saw



GIGLI
SOS 08-066

Cranial Rongeur and Conductor



MARTEL
SOS 08-067
33cm/13"

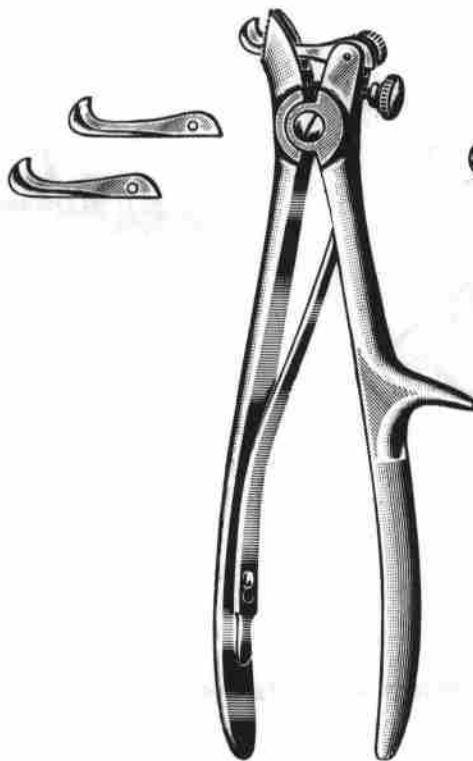

DAHLGREN
SOS 08-068
20cm/8"

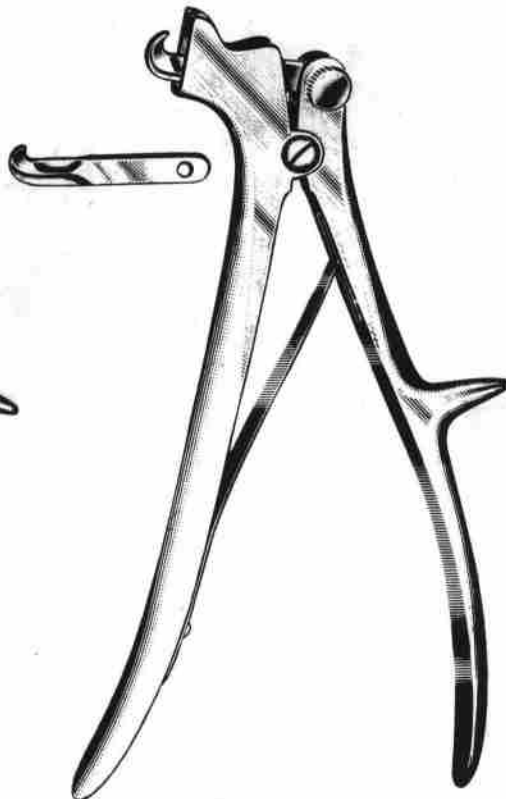

DE VILBISS
SOS 08-069
21cm/8-1/4"



Surgical Company



NEUROSURGERY

Handle Hooks and Dissector



SMITHWICK
SOS 08-070
29cm/11-1/2"



FRAZIER
Sharp Blunt
SOS 08-071 13cm/5" SOS 08-072
SOS 08-073 18cm/7" SOS 08-074



CUSHING
SOS 08-075
14cm/5-1/2"



SACHS
SOS 08-076
18.5cm/7-1/4"



GRAHAM
SOS 08-077
16.5cm/6-1/2"