

CARDIOVASCULAR

Atrauma Blood Vessel Forceps

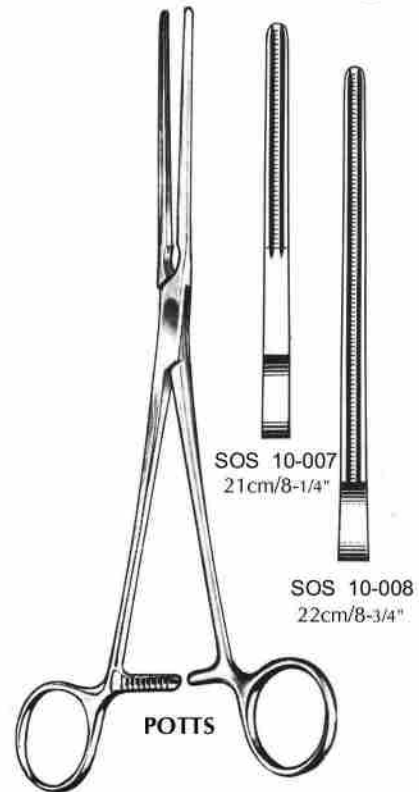
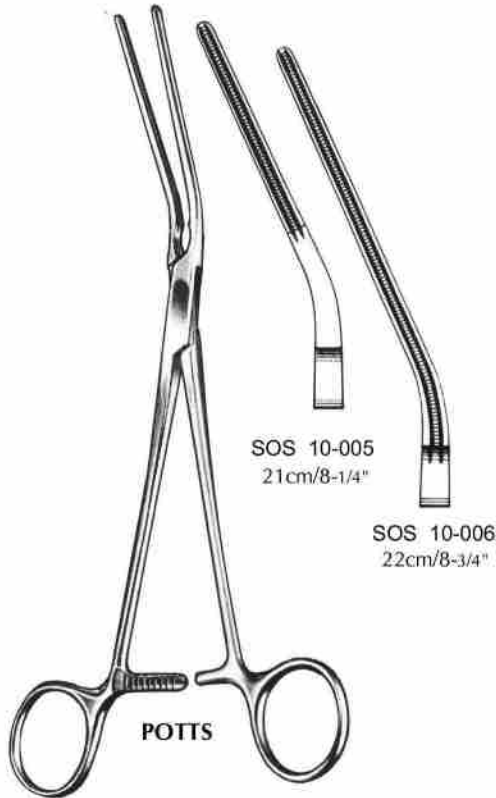
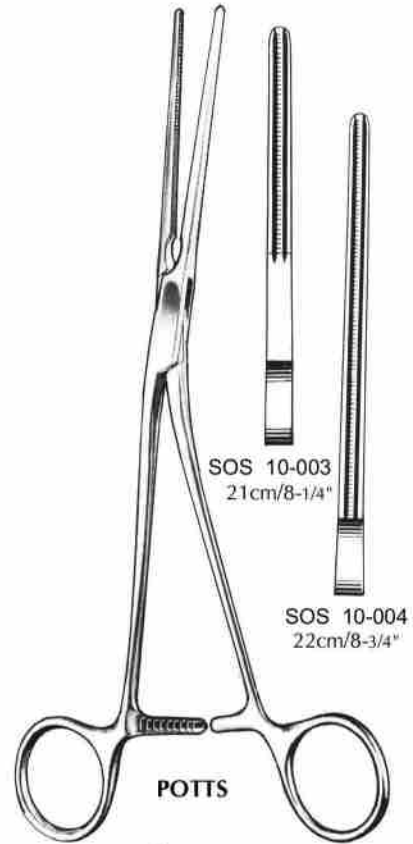
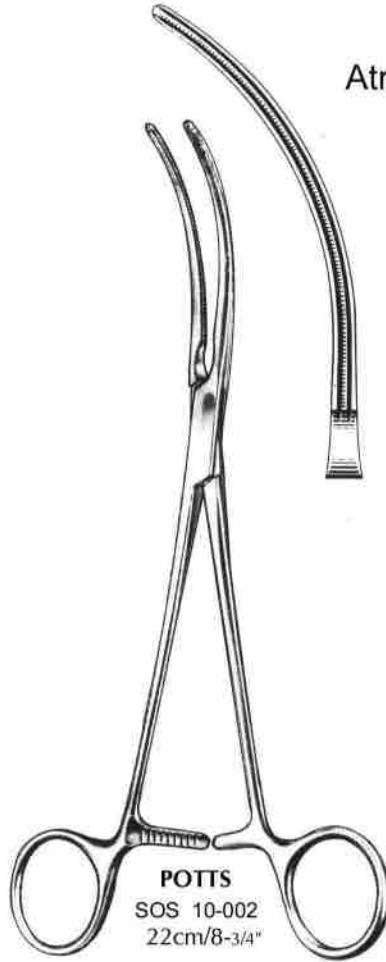

CARDIOVASCULAR

Atrauma Blood Vessel Forceps

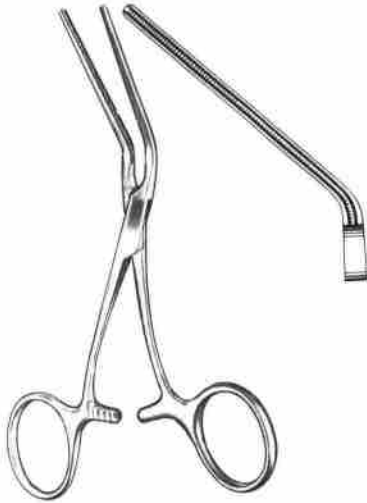

DE BAKEY
SOS 10-009
13cm/5-1/4"

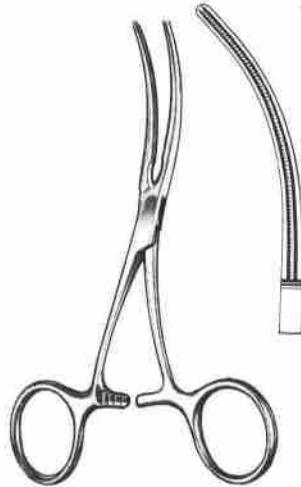

DE BAKEY
SOS 10-010
12cm/4-3/4"

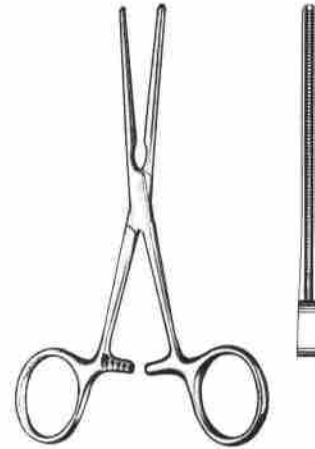

DE BAKEY
SOS 10-011
12cm/4-3/4"



SOS 10-014
23cm/9"

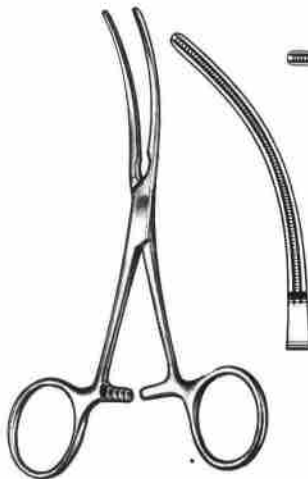

DE BAKEY
SOS 10-012
11cm/4-1/4"



DE BAKEY
SOS 10-013
10cm/4"



DE BAKEY

SOS 10-015
24cm/9-1/2"

SOS 10-016
25cm/10"

CARDIOVASCULAR

Atrauma Blood Vessel Forceps

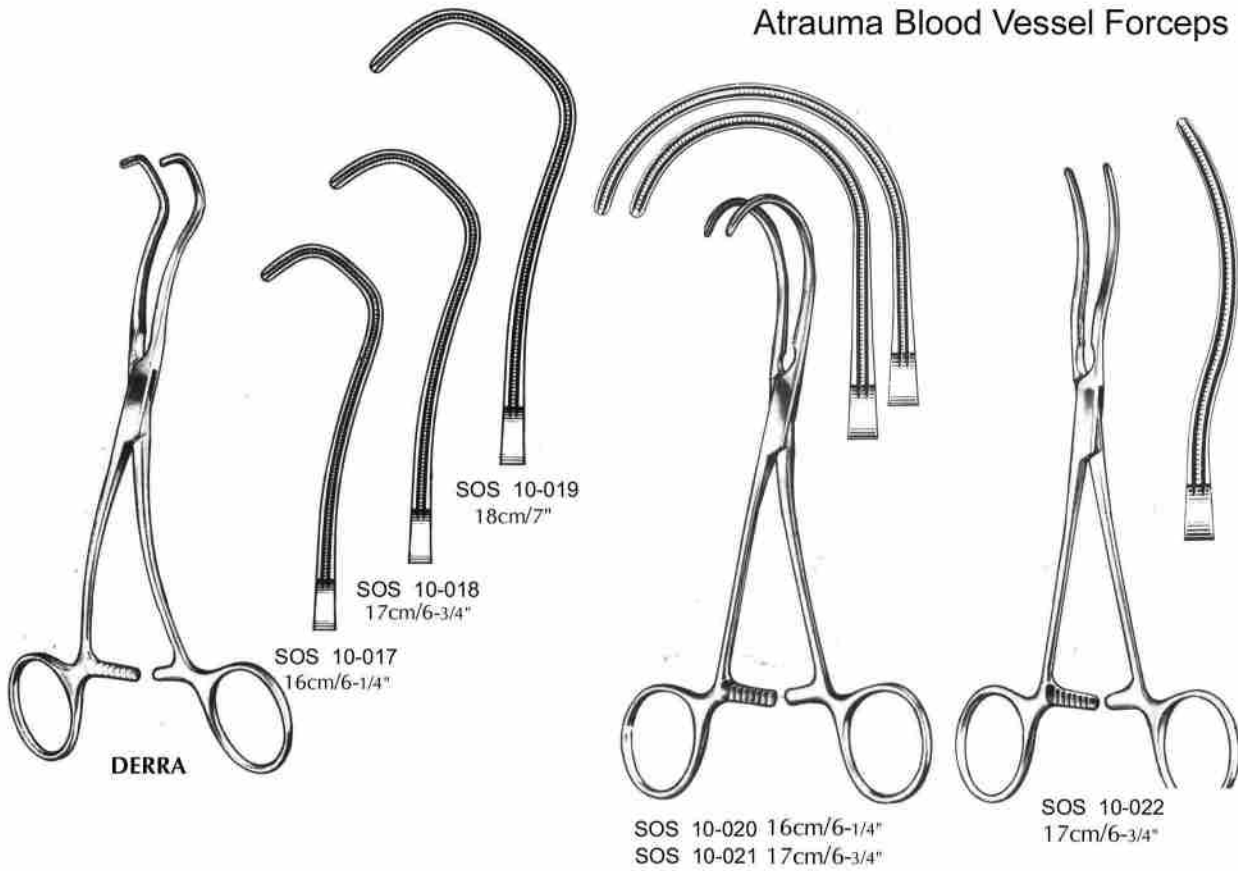

GLOVER
SOS 10-023
17cm/6-3/4"



DE BAKEY
SOS 10-024
17cm/6-3/4"

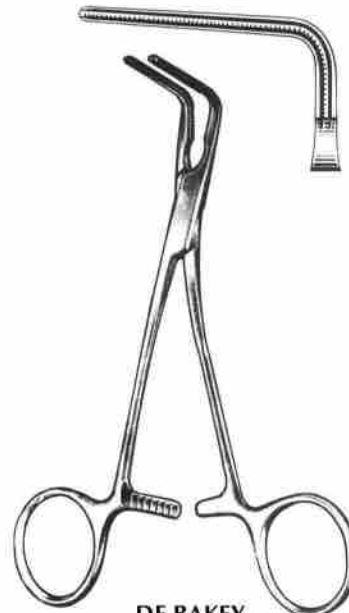

DE BAKEY
SOS 10-025
15cm/6"



Surgical Company



CARDIOVASCULAR

Atrauma Blood Vessel Forceps

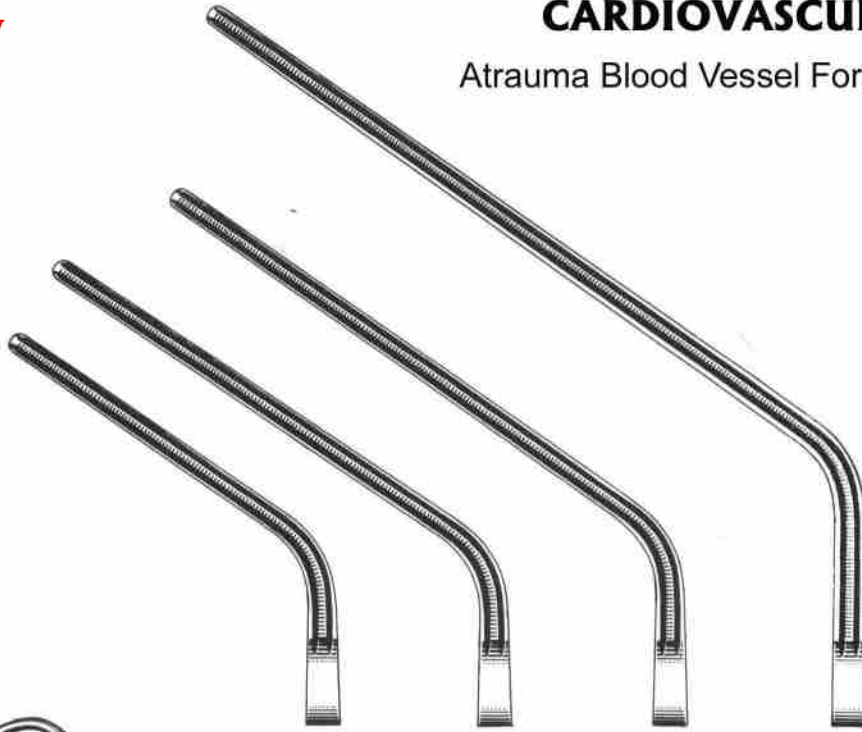

SOS 10-026
20cm/8"

SOS 10-027
21cm/8-1/4"

SOS 10-028
25cm/10"

SOS 10-029
29cm/11-3/4"

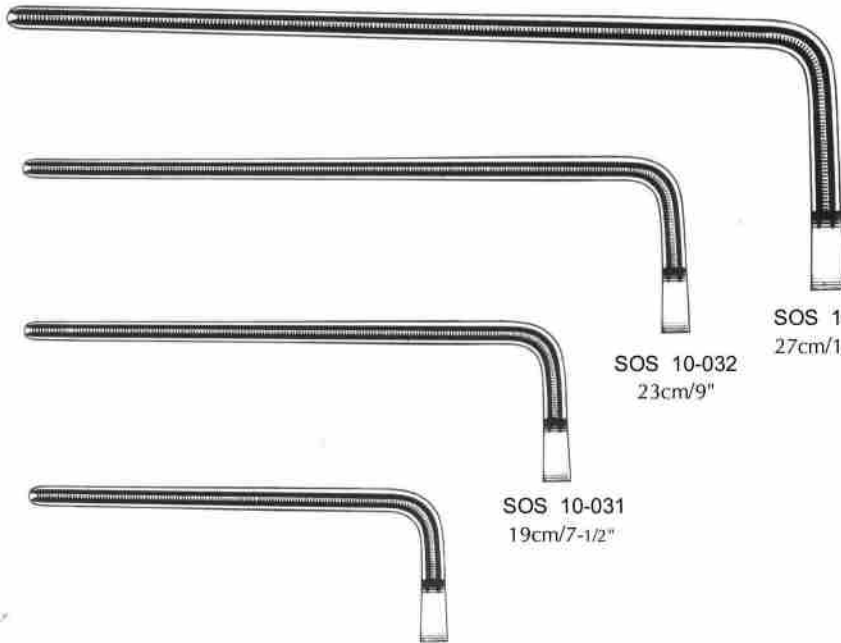

SOS 10-030
18cm/7"

SOS 10-031
19cm/7-1/2"

SOS 10-032
23cm/9"

SOS 10-033
27cm/10-1/2"

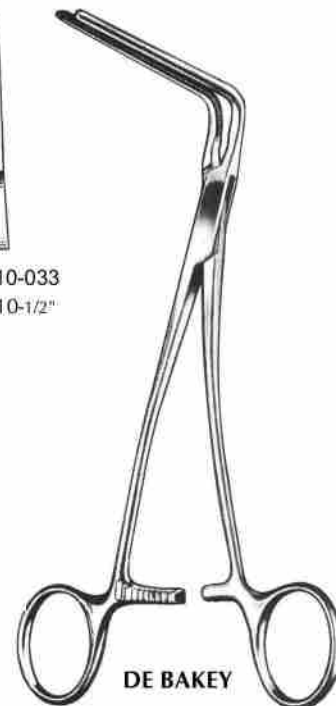

DE BAKEY



Surgical Company



CARDIOVASCULAR

Atrauma Blood Vessel Forceps



SOS 10-034
21.5cm/8-1/2"



SOS 10-035
23cm/9"



SOS 10-036
27cm/10-1/2"



SOS 10-037
31cm/12-1/2"



SOS 10-038
21.5cm/8-1/2"



SOS 10-039
23cm/9"



SOS 10-040
27cm/10-1/2"



SOS 10-041
31cm/12-1/2"





Surgical Company



CARDIOVASCULAR

Atrauma Blood Vessel Forceps



SATINSKY

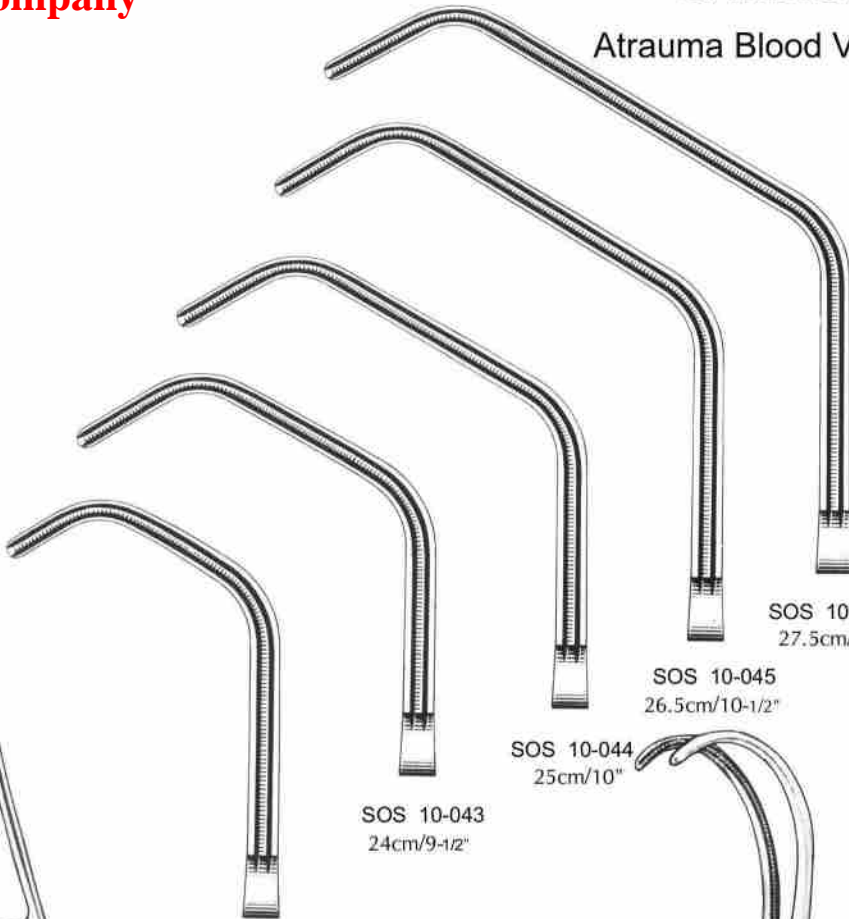

SOS 10-042
20.5cm/8"

SOS 10-043
24cm/9-1/2"

SOS 10-044
25cm/10"

SOS 10-045
26.5cm/10-1/2"

SOS 10-046
27.5cm/11"



DE BAKEY
SOS 10-047
26cm/10"



Surgical Company



CARDIOVASCULAR

Atrauma Blood Vessel Forceps

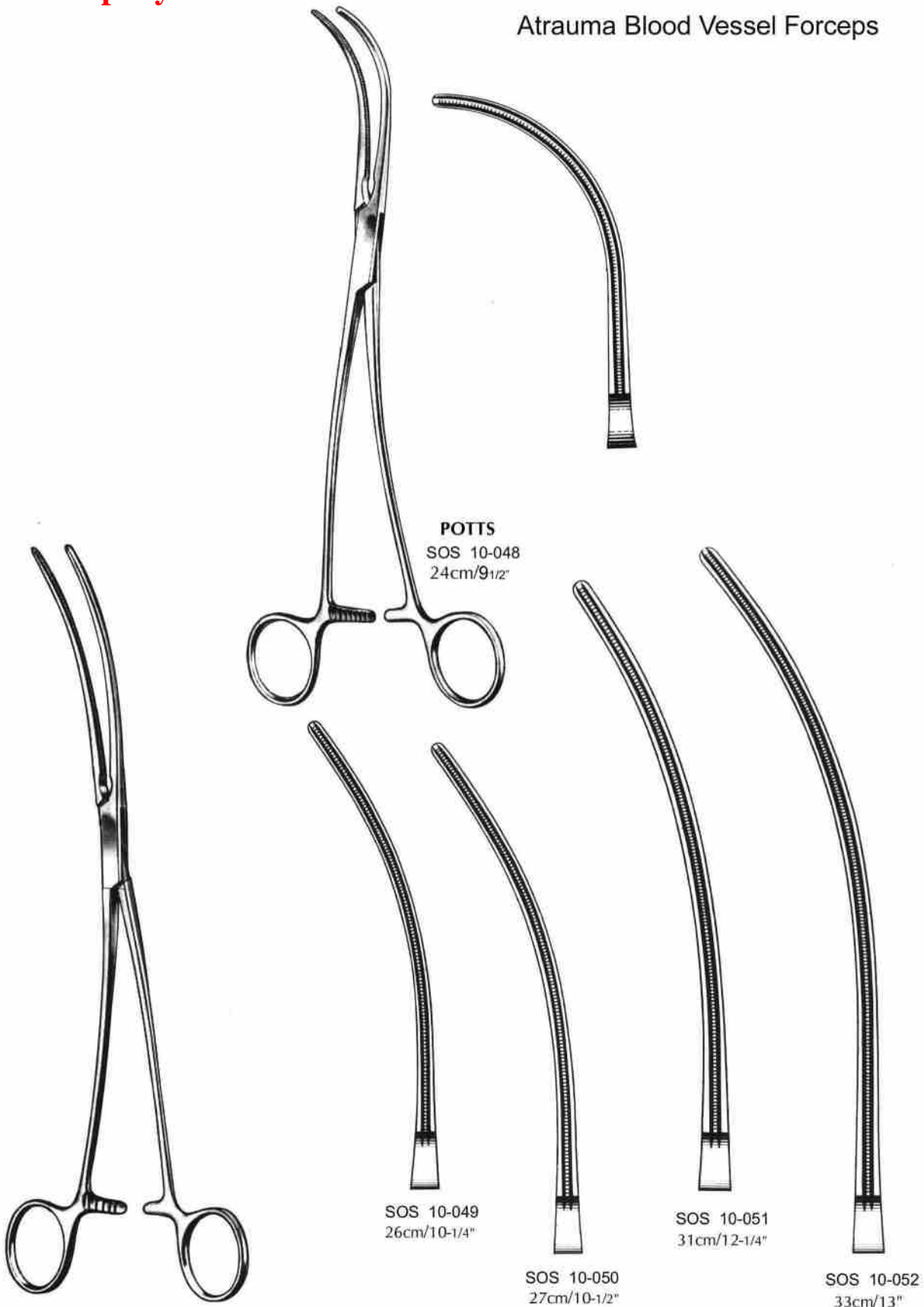

195



Surgical Company



CARDIOVASCULAR

Atrauma Blood Vessel Forceps



DE BAKEY
SOS 10-053
20cm/8"



LELAND JONES



SOS 10-055
18cm/7"

SOS 10-054
19cm/7-1/2"



SOS 10-056
20cm/8"

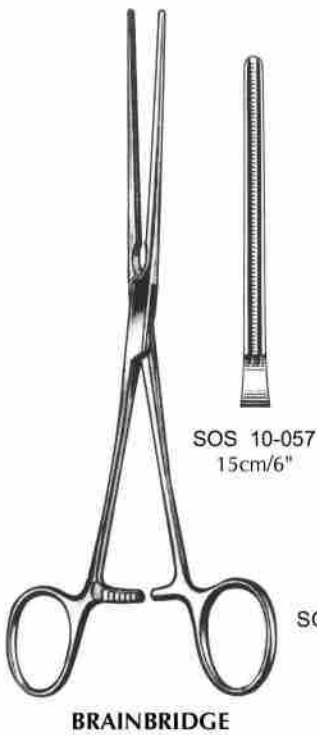

SOS 10-057
15cm/6"

BRAINBRIDGE

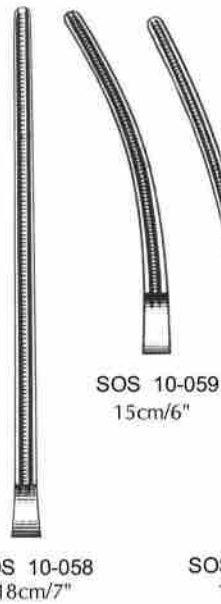

SOS 10-058
18cm/7"

SOS 10-059
15cm/6"

SOS 10-060
18cm/7"

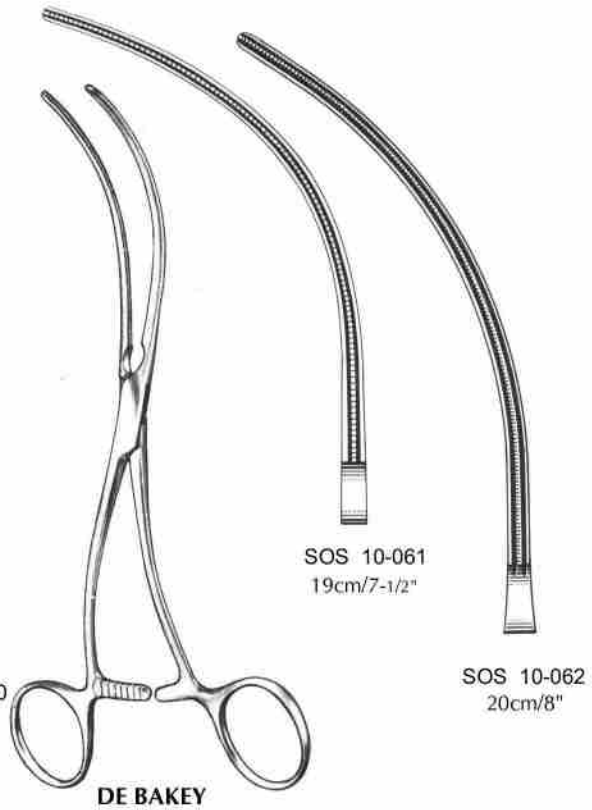

SOS 10-061
19cm/7-1/2"

DE BAKEY

SOS 10-062
20cm/8"



Surgical Company



CARDIOVASCULAR

Atrauma Blood Vessel Forceps

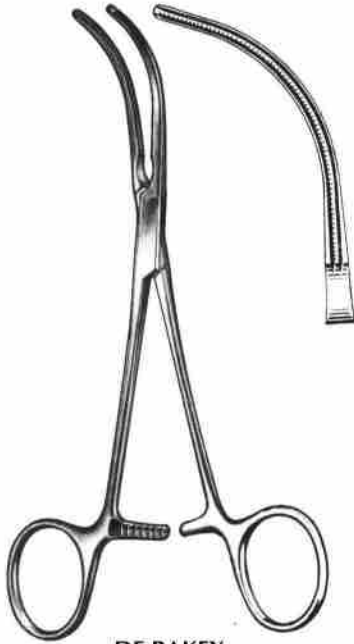

DE BAKEY
SOS 10-063
16cm/6-1/4"

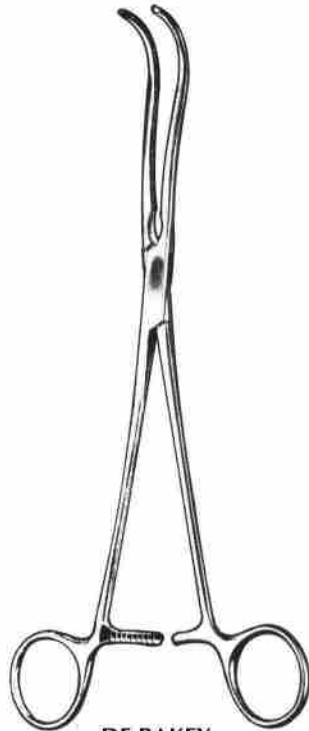

DE BAKEY



SOS 10-064
19cm/7-1/2"



SOS 10-065
23cm/9"

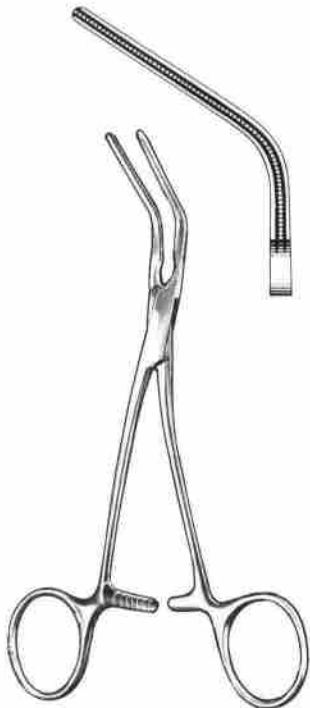

DE BAKEY
SOS 10-066
15cm/6"

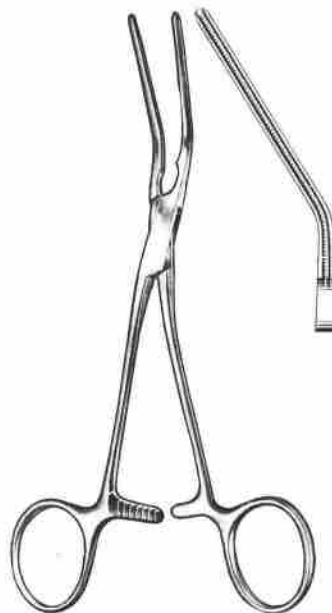

DE BAKEY
SOS 10-067
16cm/6-1/4"

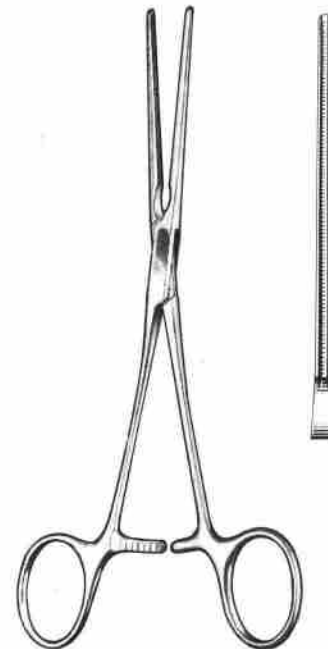

DE BAKEY
SOS 10-068
17cm/6-3/4"

197



Surgical Company



CARDIOVASCULAR

Atrauma Artery Forceps

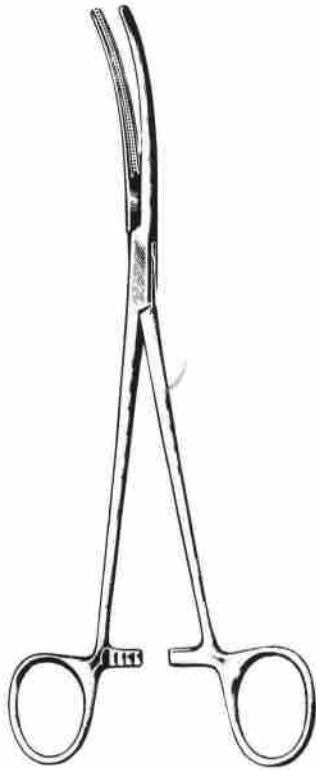

DE BAKY PEAN



SOS 10-069
16.5cm/6-1/2"

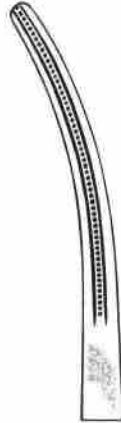

SOS 10-070
18.5cm/7-1/4"



SOS 10-071
20.5cm/8"

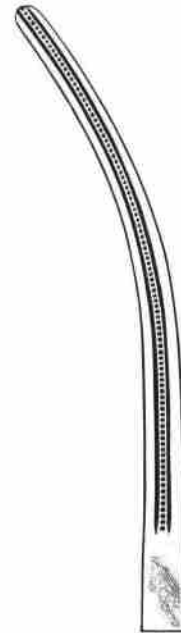

SOS 10-072
26cm/10-1/4"

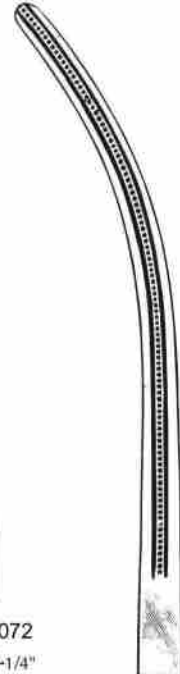

SOS 10-073
28cm/11"



198 SOS 10-074
16.5cm/6-1/4"



SOS 10-075
18.5cm/7-1/4"



SOS 10-076
20.5cm/8"



SOS 10-077
26cm/10-1/4"



SOS 10-078
28cm/11"

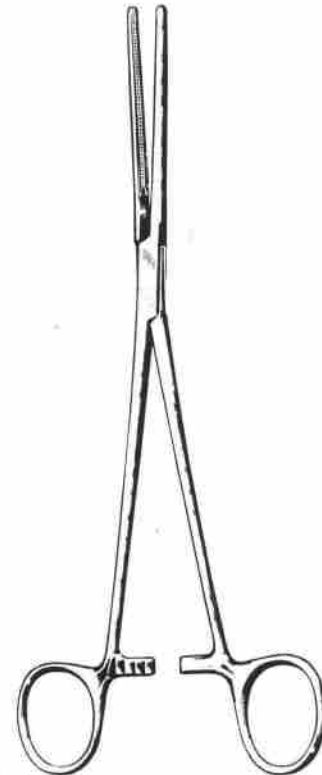

DE BAKY PEAN

CARDIOVASCULAR

Atrauma Artery Forceps

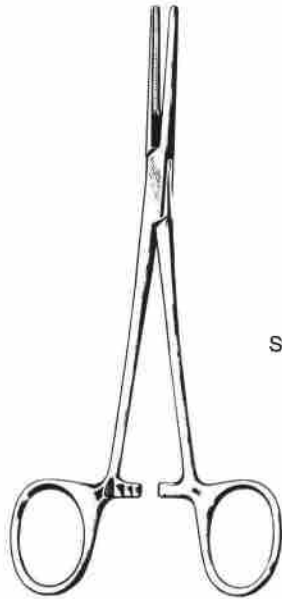

DE BAKEY RANKIN
16cm/6-1/4"

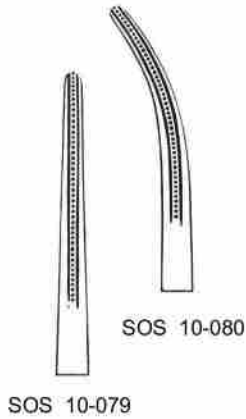

SOS 10-080

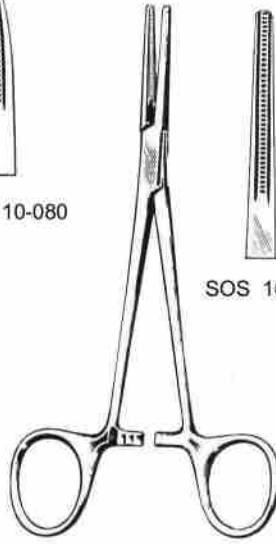

DE BAKEY KELLY
14cm/5-1/2"

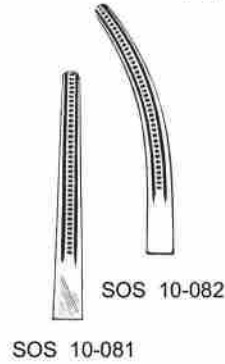

SOS 10-082



PEAN
SOS 10-083
14cm/5-1/2"



PEAN
SOS 10-084
14cm/5-1/2"

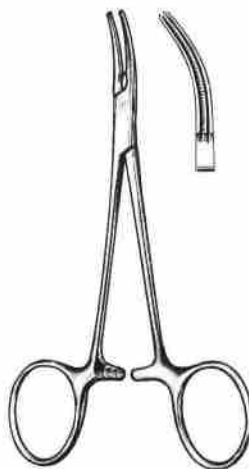

MOSQUITO
SOS 10-085
12cm/4-3/4"



MOSQUITO
SOS 10-086
12cm/4-3/4"



Surgical Company



CARDIOVASCULAR

Atrauma Artery Forceps

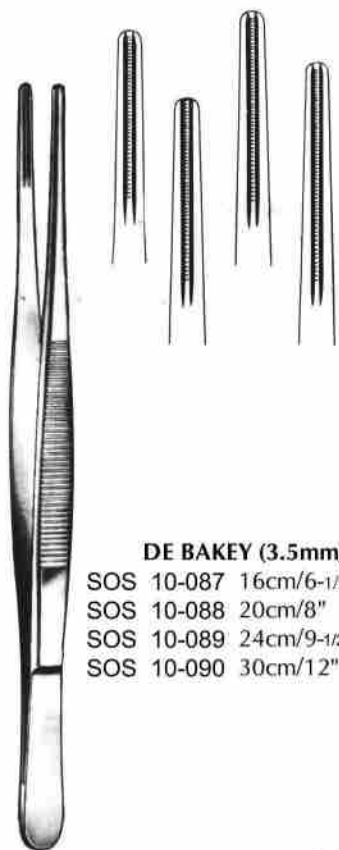

DE BAKEY (3.5mm)
 SOS 10-087 16cm/6-1/4"
 SOS 10-088 20cm/8"
 SOS 10-089 24cm/9-1/2"
 SOS 10-090 30cm/12"

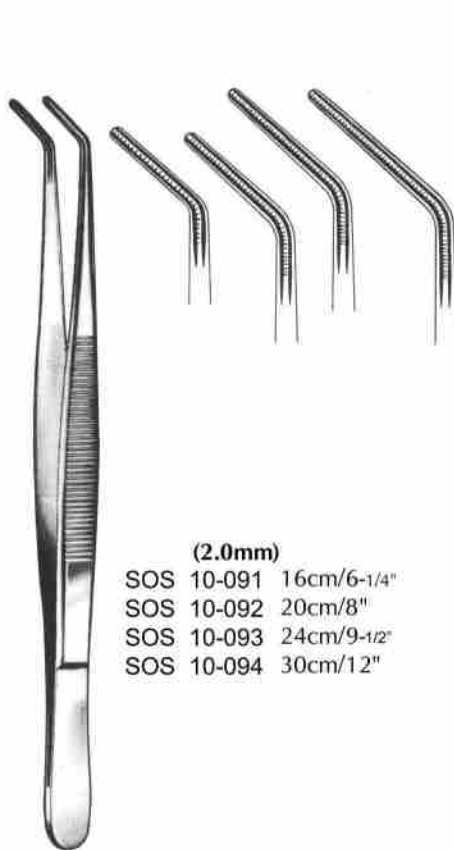

(2.0mm)
 SOS 10-091 16cm/6-1/4"
 SOS 10-092 20cm/8"
 SOS 10-093 24cm/9-1/2"
 SOS 10-094 30cm/12"

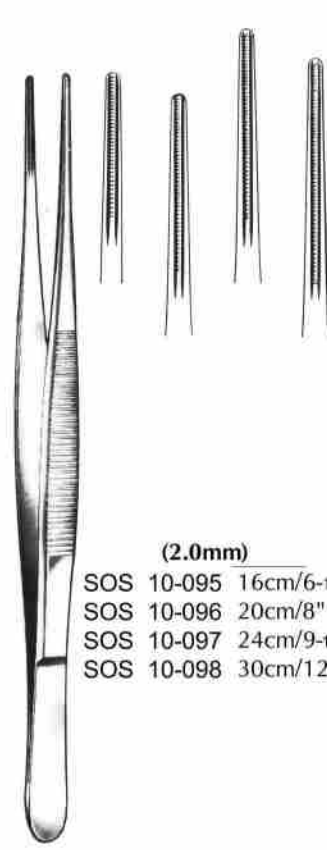

(2.0mm)
 SOS 10-095 16cm/6-1/4"
 SOS 10-096 20cm/8"
 SOS 10-097 24cm/9-1/2"
 SOS 10-098 30cm/12"



DE BAKEY (1.5mm)
 SOS 10-099 16cm/6-1/4"
 SOS 10-100 20cm/8"

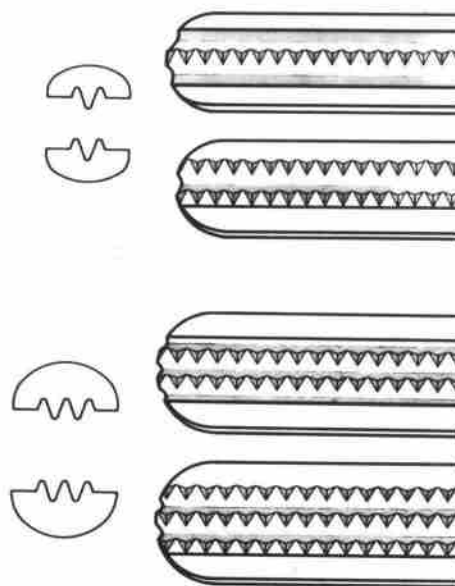



Surgical Company



CARDIOVASCULAR

Aorta Clamps

dia x width

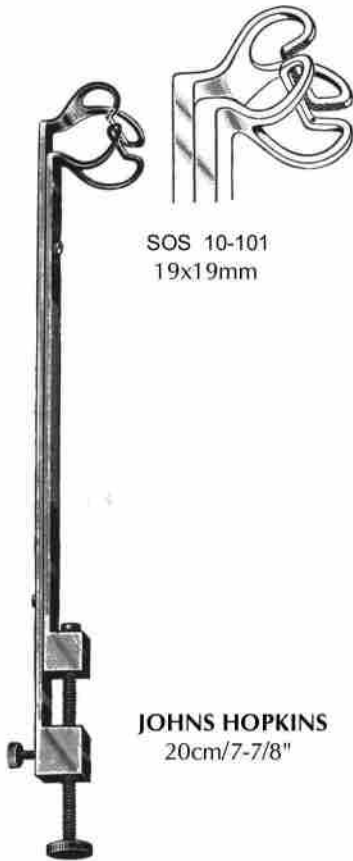

SOS 10-101
19x19mm

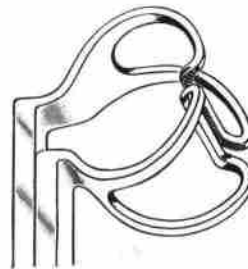

SOS 10-102
25x25mm

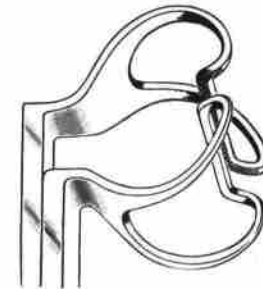

SOS 10-103
32x32mm

JOHNS HOPKINS
20cm/7-7/8"



SOS 10-104
14mm



SOS 10-105
18mm

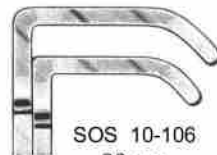

SOS 10-106
23mm

BLALOCK
SOS 10-104 15cm/6"
SOS 10-105 20cm/8"
SOS 10-106 20cm/8"

201

CARDIOVASCULAR

Blood Vessel Clamps



WANGENSTEEN
SOS 10-107
28cm/11"



HARKEN
24cm/9-1/2"

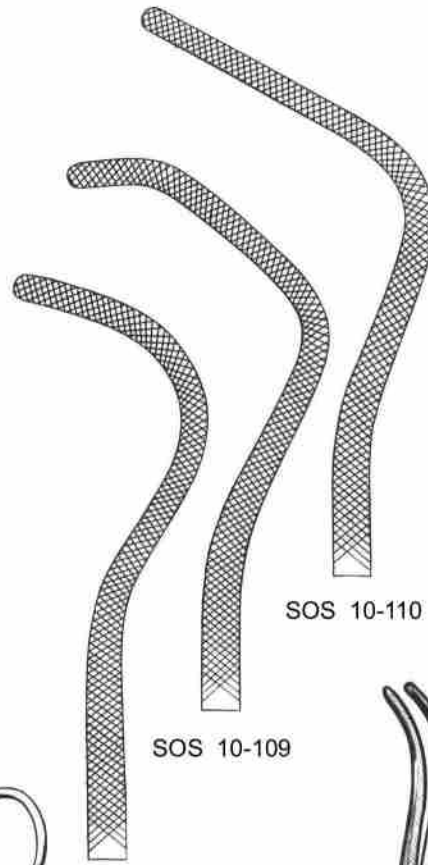

SOS 10-110

SOS 10-109

SOS 10-108

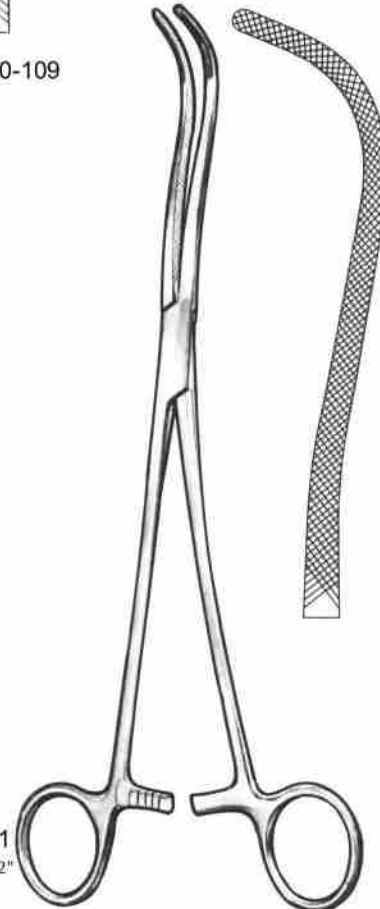

HARKEN
SOS 10-111
24cm/9-1/2"

CARDIOVASCULAR

Lung Grasping Forceps, Blood Vessel Clamps

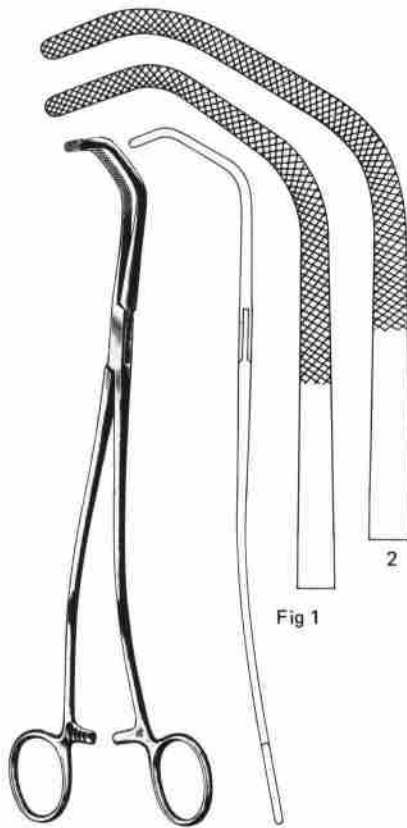

SATINSKY
26.5cm/10-1/2"
SOS 10-112 (Fig. 1)
SOS 10-113 (Fig. 2)

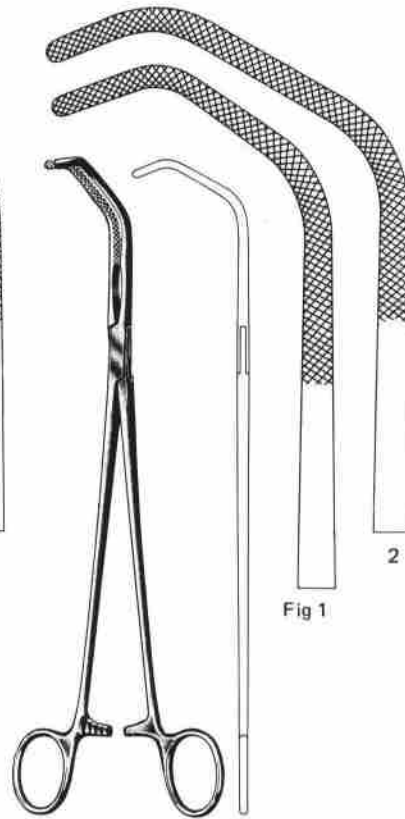

SATINSKY
26.5cm/10-1/2"
SOS 10-114 (Fig. 1)
SOS 10-115 (Fig. 2)

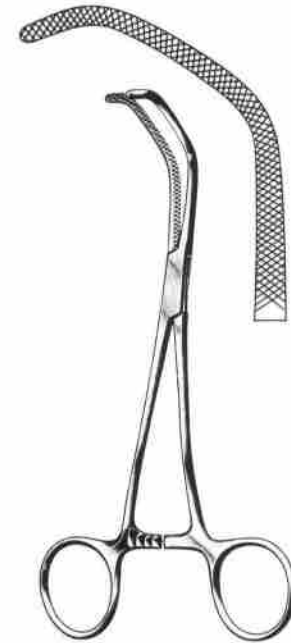

BABY SATINSKY
SOS 10-116
15cm/6"

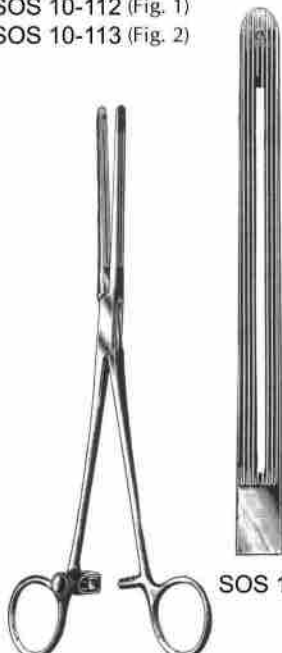

203
JOHNS HOPKINS
22cm/8-3/4"



SOS 10-117
SOS 10-118



LOVELACE
SOS 10-119
20cm/8"



LOVELACE
SOS 10-120
20cm/8"